

## FINAL STUDY REPORT

### STUDY TITLE

Germicidal and Detergent Sanitizing Action of Disinfectants

### **Test Organisms:**

*Staphylococcus aureus* (ATCC 6538)  
*Escherichia coli* (ATCC 11229)  
*Salmonella typhi* (ATCC 6539)  
Methicillin Resistant *Staphylococcus aureus* – MRSA (ATCC 33592)

### PRODUCT IDENTITY

Enagic Super 501 Strong Acidic Water 2.5 pH  
Machine 1 (Serial #: 87100333) Lot # 1  
and Machine 2 (Serial #: 87100339) Lot # 2 with pre-filter C-1000

### DATA REQUIREMENTS

U.S. EPA 40 CFR Part 158  
"Data Requirements for Registration"  
Pesticide Assessment Guidelines - Subdivision G, 91-2 (k)

### AUTHOR

Anne Stemper, B.S.  
Study Director

### STUDY COMPLETION DATE

June 22, 2010

### PERFORMING LABORATORY

ATS Labs  
1285 Corporate Center Drive, Suite 110  
Eagan, MN 55121

### SPONSOR

YNR Marketing  
Box 7735  
Laguna Niguel, CA 92607

### PROJECT NUMBER

A09385

Page 1 of 47

---

**STATEMENT OF NO DATA CONFIDENTIALITY CLAIMS**

No claim of confidentiality is made for any information contained in this study on the basis of its falling within the scope of FIFRA Section 10 (d) (1) (A), (B), or (C).

Company: YNR Marketing

Company Agent: \_\_\_\_\_

\_\_\_\_\_

Title

\_\_\_\_\_

Signature

Date: \_\_\_\_\_

**GOOD LABORATORY PRACTICE STATEMENT**

The study referenced in this report was conducted in compliance with U.S. Environmental Protection Agency Good Laboratory Practice (GLP) regulations set forth in 40 CFR Part 160.

The studies not performed by or under the direction of ATS Labs are exempt from this Good Laboratory Practice Statement and include: characterization and stability of the compounds.

Submitter: \_\_\_\_\_

Date: \_\_\_\_\_

Sponsor: \_\_\_\_\_

Date: \_\_\_\_\_

Study Director: \_\_\_\_\_

  
Anne Stemper, B.S.

Date: 6-22-13

**QUALITY ASSURANCE UNIT SUMMARY**

Study: Germicidal and Detergent Sanitizing Action of Disinfectants

The objective of the Quality Assurance Unit is to monitor the conduct and reporting of nonclinical laboratory studies. These studies have been performed under Good Laboratory Practice regulations (40 CFR Part 160) and in accordance to standard operating procedures and standard protocols. The Quality Assurance Unit maintains copies of study protocols and standard operating procedures and has inspected this study on the dates listed below. Studies are inspected at time intervals to assure the integrity of the study.

Phase Inspected	Date of Phase Inspection	Date Reported to Study Director	Date Reported to Management
Critical Phase Audit	April 30, 2010	April 30, 2010	May 11, 2010
Draft Report	May 6, 2010	May 7, 2010	
Final Report	June 18, 2010	June 18, 2010	June 22, 2010

The findings of these inspections have been reported to management and the Study Director.

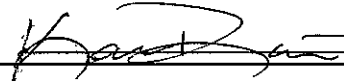
Quality Assurance Auditor:  Date: 6/23/10

## TABLE OF CONTENTS

Title Page.....	1
Statement of No Data Confidentiality Claims .....	2
Good Laboratory Practice Statement .....	3
Quality Assurance Unit Summary .....	4
Table of Contents.....	5
Study Personnel.....	6
General Study Information.....	7
Test Substance Identity .....	7
Study Dates .....	7
Objective .....	7
Summary of Results.....	8
Study Materials .....	9
Test Method .....	10
Study Controls .....	13
Study Acceptance Criteria .....	14
Protocol Changes .....	14
Data Analysis .....	15
Study Retention .....	15
References.....	16
Results .....	16
Analysis.....	17
Conclusion .....	18
Table 1: Control Results .....	19
Table 2: Neutralization Confirmation Control Results.....	20
Table 3: Test Results – <i>Staphylococcus aureus</i> (ATCC 6538) .....	21
Table 4: Test Results - <i>Escherichia coli</i> (ATCC 11229) .....	22
Table 5: Test Results - <i>Salmonella typhi</i> (ATCC 6539).....	23
Table 6: Test Results - Methicillin Resistant <i>Staphylococcus aureus</i> - MRSA (ATCC 33592) .....	24
Table 7: Verification of Antibiotic Resistance .....	25
Test Protocol.....	26

## STUDY PERSONNEL

STUDY DIRECTOR: Anne Stemper, B.S.

Professional personnel involved:

Amy S. Jeske, B.S.	- Manager, Microbiology Operations
Scott R. Steinagel, B.S.	- Manager, Microbiology Laboratory Operations
Joshua Luedtke, M.S.	- Research Scientist I
Adam W. Pitt, B.S.	- Research Assistant II
Peter Toll, B.S.	- Research Assistant II
Megan Polos, B.S.	- Research Assistant I
Jessica Underwood, B.S.	- Research Assistant I
Christine Chan, B.S.	- Research Assistant I

## STUDY REPORT

### GENERAL STUDY INFORMATION

**Study Title:** Germicidal and Detergent Sanitizing Action of Disinfectants  
**Project Number:** A09385  
**Protocol Number:** YNR01040110.GDST  
**Sponsor:** YNR Marketing  
Box 7735  
Laguna Niguel, CA 92607  
**Test Facility:** ATS Labs  
1285 Corporate Center Drive, Suite 110  
Eagan, MN 55121

### TEST SUBSTANCE IDENTITY

**Test Substance Name:** Enagic Super 501 Strong Acidic Water 2.5 pH  
**Lot/Batch(s):** Machine 1 (Serial #: 87100333) Lot # 1 and Machine 2 (Serial #: 87100339)  
Lot # 2 with pre-filter C-1000

### Test Substance Characterization

Test substance characterization as to content, stability, etc., (40 CFR, Part 160, Subpart F [160.105]) is the responsibility of the Sponsor.

### STUDY DATES

**Date Machines Received:** April 7, 2009  
**Date Pre-filter C-1000 Received:** March 24, 2010  
**Date of Test Substance Preparation:** April 27, 2010  
**Study Initiation Date:** April 19, 2010  
**Experimental Start Date:** April 28, 2010  
**Experimental End Date:** April 30, 2010  
**Study Completion Date:** June 22, 2010

### OBJECTIVE

The objective of this assay was to determine the minimum concentration of chemical that can be used in sanitizing precleaned, nonporous food contact surfaces using the AOAC Germicidal and Detergent Sanitizing Action of Disinfectants method.

**SUMMARY OF RESULTS**

Test Substance: Enagic Super 501 Strong Acidic Water 2.5 pH, Machine 1 (Serial #: 87100333) Lot # 1 and Machine 2 (Serial #: 87100339) Lot # 2 with pre-filter C-1000

Test Organisms: *Staphylococcus aureus* (ATCC 6538)  
*Escherichia coli* (ATCC 11229)  
*Salmonella typhi* (ATCC 6539)  
Methicillin Resistant *Staphylococcus aureus* – MRSA (ATCC 33592)

Exposure Time: 30 seconds

Exposure Temperature: Room temperature (20.0°C)

Organic Soil Load: 5% fetal bovine serum

Efficacy Result: Enagic Super 501 Strong Acidic Water 2.5 pH demonstrated efficacy of two lots against *Staphylococcus aureus*, and therefore, meets the requirements set forth by the U.S. EPA for sanitizer label claims following a 30 second exposure time at room temperature (20.0°C) in the presence of a 5% fetal bovine serum organic soil load.

Enagic Super 501 Strong Acidic Water 2.5 pH demonstrated efficacy of two lots against *Escherichia coli*, and therefore, meets the requirements set forth by the U.S. EPA for sanitizer label claims following a 30 second exposure time at room temperature (20.0°C) in the presence of a 5% fetal bovine serum organic soil load.

Enagic Super 501 Strong Acidic Water 2.5 pH demonstrated efficacy of two lots against *Salmonella typhi*, and therefore, meets the requirements set forth by the U.S. EPA for sanitizer label claims following a 30 second exposure time at room temperature (20.0°C) in the presence of a 5% fetal bovine serum organic soil load.

Enagic Super 501 Strong Acidic Water 2.5 pH demonstrated efficacy of two lots against Methicillin Resistant *Staphylococcus aureus* – MRSA, and therefore, meets the requirements set forth by the U.S. EPA for sanitizer label claims following a 30 second exposure time at room temperature (20.0°C) in the presence of a 5% fetal bovine serum organic soil load.



**STUDY MATERIALS**

**Test System/Growth Media**

Test Organism	ATCC #	Growth Medium	Incubation Parameters
<i>Staphylococcus aureus</i>	6538	Nutrient Agar A & B	35-37°C, aerobic
<i>Escherichia coli</i>	11229	Nutrient Agar A & B	35-37°C, aerobic
<i>Salmonella typhi</i>	6539	Nutrient Agar A & B	35-37°C, aerobic
Methicillin Resistant <i>Staphylococcus aureus</i> – MRSA	33592	Nutrient Agar A & B	35-37°C, aerobic

The microorganisms used in this study were obtained from the American Type Culture Collection (ATCC), Manassas, Virginia.

**Recovery Media:**

Neutralizer: Modified Fluid Thioglycollate Medium  
Subculture Medium: Tryptone Glucose Extract Agar (TGEA)

**Reagents**

Organic Soil Load Description:

A 0.40 mL aliquot of fetal bovine serum was added to 7.6 mL of each broth culture to yield a 5% fetal bovine serum soil load.

## **TEST METHOD**

### **Preparation of Test Substance**

The Sponsor supplied two machine units, Machine 1 (Serial #: 87100333) and Machine 2 (Serial #: 87100339) with pre-filter C-1000, to generate two lots of Strong Acidic Water 2.5 pH to be used in testing. Each machine was also connected to a corresponding pre-filter C-1000 unit. Lot # 1 was prepared using Machine 1 and pre-filter C-1000 # 1 and Lot # 2 was prepared using Machine 2 and pre-filter C-1000 # 2. Each lot of test substance was prepared as follows on April 27, 2010.

The corporation cock supplied by the Sponsor was installed in an appropriate manner to tap water faucet # 2 in the ATS Labs Microbiology Laboratory. Each main machine unit was installed following the operations manual supplied by the Sponsor. Each machine unit was primed prior to use in testing following the Sponsor provided instructions. The priming procedure was performed on April 23, 2009. Each machine was appropriately connected to be used in combination with the appropriate pre-filter C-1000 unit supplied by the Sponsor.

Each machine was set up to produce the strong acidic water. Prior to producing the strong acidic water, the temperature of the tap water running through each machine was recorded. The temperature of the tap water used to generate Lot # 1 was 18.0°C and the temperature of the tap water used to generate Lot # 2 was 17.0°C.

The flow rate of the tap water was set to approximately 0.4 gallons/minute and the flow rate was adjusted as needed per the message on the machine display.

The ionizing accelerator (sodium chloride) was prepared for each machine following the instructions in the operations manual supplied by the Sponsor. A 300 g sample of sodium chloride, supplied by ATS Labs, was measured using the measuring cup supplied by the Sponsor. The sample was diluted as specified in the operations manual and added to the built-in tank located on the back of the machine unit. This procedure was performed for each machine.

Each machine was turned on, the water supply was turned on, then the "Strong Acid" button located on the operation panel was pressed. The appropriate volume of Lot # 1 and Lot # 2 was collected from the respective machine and the "Stop" button located on the operation panel was pressed when the generation of strong acidic water was no longer required.

ATS Labs performed a pH reading for each lot of strong acidic water generated. The pH was determined using the Fisher Scientific accument<sup>®</sup> pH meter. The pH of Lot # 1 was 2.68 and the pH of Lot # 2 was 2.73. The temperature of each lot of strong acidic water was also taken. The temperature of Lot # 1 was 18.0°C and Lot # 2 was 17.0°C.

Following preparation, each lot of strong acidic water was stored in a sterile glass container, wrapped in aluminum foil and stored at room temperature for less than 24 hours prior to use in testing.

Following the use of each machine, the built-in sodium chloride tank was detached from the machine unit and rinsed well with tap water. While each unit was stopped, the air discharge pipe located at the upper part of the unit was cleaned by feeding approximately 20-50 cc of tap water through the hose using the Sponsor provided wash bottle.

Each prepared test substance was homogenous as determined by visual observation.

### Preparation of Test Organism

For *Staphylococcus aureus*, the test organism was transferred daily on Nutrient agar A slants. Three to thirty consecutive daily transfers were performed prior to the inoculation of agar bottles. The bacterial growth was washed from a  $24 \pm 2$  hour Nutrient Agar A slant of the test organism using 5.0 mL phosphate buffer dilution water (PBDW). This growth suspension was aspirated and added to 99.0 mL PBDW. A 2.0 mL aliquot of this suspension was inoculated onto eight French square bottles containing Nutrient agar B. The bottles were tilted back and forth to distribute the inoculum. The excess inoculum was aspirated off. The bottles were incubated for 18-24 hours at 35-37°C (agar side down). After incubation, the culture was harvested from the bottles using PBDW and approximately 15-20 sterile glass beads to target  $1 \times 10^{10}$  CFU / mL. A 1.5 mL aliquot of PBDW, per bottle, was used to harvest the test organism. The suspension was removed from the bottles, filtered through sterile Whatman No. 2 paper pre-wetted with approximately 1.00 mL sterile of PBDW, and collected into a sterile vessel.

The test organism culture suspension was placed in a spectrophotometer and the absorbance value was recorded at 620 nm. The absorbance value for the *Staphylococcus aureus* culture suspension was 2.467 and no adjustments were necessary.

For *Escherichia coli*, the test organism was transferred daily on Nutrient agar A slants. Three to thirty consecutive daily transfers were performed prior to the inoculation of agar bottles. The bacterial growth was washed from a  $24 \pm 2$  hour Nutrient Agar A slant of the test organism using 5.0 mL phosphate buffer dilution water (PBDW). This growth suspension was aspirated and added to 99.0 mL PBDW. A 2.0 mL aliquot of this suspension was inoculated onto four French square bottles containing Nutrient agar B. The bottles were tilted back and forth to distribute the inoculum. The excess inoculum was aspirated off. The bottles were incubated for 18-24 hours at 35-37°C (agar side down). After incubation, the culture was harvested from the bottles using PBDW and approximately 15-20 sterile glass beads to target  $1 \times 10^{10}$  CFU / mL. A 3.0 mL of PBDW, per bottle, was used to harvest the test organism. The suspension was removed from the bottles, filtered through sterile Whatman No. 2 paper pre-wetted with approximately 1.00 mL sterile of PBDW, and collected into a sterile vessel.

The test organism culture suspension was placed in a spectrophotometer and the absorbance value was recorded at 620 nm. The absorbance value for the *Escherichia coli* culture suspension was 2.030 and a 5.0 mL aliquot of PBDW was added to the culture suspension. The absorbance reading was taken again and was 1.785. No additional adjustments to the culture suspension were necessary.

*Salmonella typhi* was transferred daily on Nutrient agar A agar slants. Three to thirty consecutive daily transfers were performed prior to the inoculation of agar bottles. The bacterial growth was washed from a  $24 \pm 2$  hour slant of the test organism using 5.0 mL phosphate buffer dilution water (PBDW). This growth suspension was aspirated and added to 99.0 mL PBDW. A 2.0 mL aliquot of this suspension was inoculated onto 12 French square bottles containing Nutrient agar B. The bottles were tilted back and forth to distribute the inoculum. The excess inoculum was aspirated off. The bottles were incubated for 18-24 hours at 35-37°C (agar side down). After incubation, each suspension was harvested from the bottles using PBDW and 15-20 sterile glass beads to target  $1 \times 10^{10}$  CFU / mL. A 1.00 mL aliquot of PBDW was used, per bottle, to harvest this organism. The suspension was removed from the bottles, filtered through sterile Whatman No. 2 paper pre-wetted with approximately 1.00 mL sterile of PBDW, and collected into a sterile vessel.

The test organism culture suspension was placed in a spectrophotometer and the absorbance value was recorded at 620 nm. The absorbance value for the *Salmonella typhi* culture suspension was 2.019 and a 2.00 mL aliquot of PBDW was added to the culture suspension. The absorbance reading was taken again and was 1.958. No additional adjustments to the culture suspension were necessary.

Methicillin Resistant *Staphylococcus aureus* was transferred daily on Nutrient agar A agar slants. Three to thirty consecutive daily transfers were performed prior to the inoculation of agar bottles. The bacterial growth was washed from a  $24 \pm 2$  hour slant of the test organism using 5.0 mL phosphate buffer dilution water (PBDW). This growth suspension was aspirated and added to 99.0 mL PBDW. A 2.0 mL aliquot of this suspension was inoculated onto five French square bottles containing Nutrient agar B. The bottles were tilted back and forth to distribute the inoculum. The excess inoculum was aspirated off. The bottles were incubated for 18-24 hours at 35-37°C (agar side down). After incubation, each suspension was harvested from the bottles using PBDW and 15-20 sterile glass beads to target  $1 \times 10^{10}$  CFU / mL. A 3.0 mL aliquot of PBDW was used, per bottle, to harvest this organism. The suspension was removed from the bottles, filtered through sterile Whatman No. 2 paper pre-wetted with approximately 1.00 mL sterile of PBDW, and collected into a sterile vessel.

The test organism culture suspension was placed in a spectrophotometer and the absorbance value was recorded at 620 nm. The absorbance value for the Methicillin Resistant *Staphylococcus aureus* culture suspension was 2.185 and a 3.0 mL aliquot of PBDW was added to the culture suspension. The absorbance reading was taken again and was 2.078. No additional adjustments to the culture suspension were necessary.

Antimicrobial susceptibility testing was performed utilizing a representative culture from the day of testing to verify the antimicrobial resistance pattern stated.

Methicillin Resistant *Staphylococcus aureus* (ATCC 33592) was purchased from the American Type Culture Collection (ATCC) by ATS Labs. ATS Labs verified that the organism was resistant by performing a Kirby Bauer Susceptibility assay on the day of testing. The organism was subcultured onto a Tryptic Soy + 5% Sheep Blood agar plate and was incubated for 24 hours at 35-37°C. Following incubation, a suspension of the test organism equal to a 0.5 McFarland Standard was made in 0.85% sterile saline. The suspension was streaked onto Mueller Hinton agar plate in three planes. An oxacillin disc was placed in the center of the inoculated Mueller Hinton agar plate. The plate was inverted and incubated for  $\geq 24$  hours at 35-37°C. Following incubation, the zone of inhibition was measured using a calibrated caliper. A control organism, *Staphylococcus aureus* (ATCC 25923), was run concurrently with the test organism to confirm the validity of the assay. The interpretation of the zone of inhibition is based on established performance standards of the Clinical and Laboratory Standards Institute (CLSI). See Table 4 for results.

An organic soil load was added to the test culture per the Sponsor's request.

#### **Inoculation of Flasks**

Duplicate 250 – 300 mL Erlenmeyer flasks containing 99.0 mL of the test substance at the concentration to be tested were placed into a room temperature (20.0°C) waterbath and was allowed to equilibrate for  $\geq 20$  minutes.

Flasks containing 99.0 mL sterile PBDW were prepared to be used for "initial numbers" control. The PBDW was placed in the room temperature (20.0°C) waterbath and allowed to equilibrate  $\geq 20$  minutes. A volume of 1.00 mL of culture suspension was added to each flask as follows:

- a) The flask was whirled in a circular motion, and stopped just before the suspension was added, which created enough residual motion of liquid to prevent pooling of the suspension at the point of contact with the test substance.

- b) The test organism suspension was added midway between the center and the edge of the surface with the tip of the pipette slightly immersed in test solution. Touching of the pipette to the neck or side of the flask during addition of the test organism suspension was avoided.

#### **Neutralization/Subculture**

At the specified exposure time point, one (1.00) mL of the inoculated test substance was transferred to 9 mL of neutralizer. The neutralizer was vortex mixed. Four 1.0 mL and 0.1 mL aliquots were transferred to individual sterile Petri dishes. A sufficient volume (approximately 15-25 mL) of tryptone glucose extract agar was transferred to each Petri dish and each dish was allowed to solidify.

#### **Incubation and Observation**

The subculture plates were incubated for approximately 48 hours at 35-37°C before enumeration of survivors. Following incubation, the plates were visually examined for growth.

### **STUDY CONTROLS**

#### **Purity Control**

A "streak plate for isolation" was performed on the organism culture and following incubation examined in order to confirm the presence of a pure culture. The acceptance criterion for this study control is a pure culture demonstrating colony morphology typical of the test organism.

#### **Neutralizer Sterility Control**

A representative sample of uninoculated neutralizer (1.00 mL) was transferred to a sterile Petri dish and pour plated using TGEA, incubated, and visually examined. The acceptance criterion for this study control is lack of growth.

#### **Organic Soil Sterility Control**

The serum used for soil load was cultured, incubated, and observed for lack of growth. The acceptance criterion for this study control is lack of growth.

#### **PBDW Sterility Control**

A representative sample of PBDW (1.00 mL) was transferred to a sterile plate and pour plated using TGEA. The plate was incubated and visually examined. The acceptance criterion for this study control is lack of growth.

#### **Subculture Agar Sterility Control**

One sample of the subculture agar was pour plated at the end of testing, incubated with the test and visually examined. The acceptance criterion for this study control is lack of growth.

#### **Viability Control**

An aliquot of the test organism (0.10 mL) was transferred to a plate and the subculture agar added and allowed to harden. The plates were incubated and visually examined. The acceptance criterion for this study control is growth.

### **Numbers Control**

Prior to addition of the organism, the PBDW was placed in the room temperature (20.0°C) waterbath and allowed to equilibrate for  $\geq 20$  minutes. For each organism on the day of testing, one (1.00) mL of the initial suspension was added to 99.0 mL of PBDW representing the "Test Substance". A volume of 1.00 mL of this suspension was added to 99.0 mL PBDW (Dilution 1, representing the  $10^{-2}$  dilution). After mixing thoroughly, 1.00 mL of Dilution 1 was transferred to 99.0 mL PBDW (Dilution 2, representing the  $10^{-4}$  dilution). A third dilution was made using 1.00 mL Dilution 2 into 99.0 mL PBDW (Dilution 3, representing the  $10^{-6}$  dilution). Four 1.0 mL and four 0.1 mL aliquots from Dilution 3 were transferred to individual Petri dishes. Approximately 15-25 mL of TGEA was added to each plate. The plate was swirled to mix and the agar was cooled to solidify. The plates were inverted and incubated with the test. The acceptance criterion for this study control is a calculated result between 75 and  $125 \times 10^6$  CFU/mL of "test substance".

### **Neutralization Confirmation Control**

Aliquots of 1.0 mL and 0.1 mL of the neutralization control samples (a 9 mL neutralizer tube inoculated with 1.0 mL of the test substance) were transferred to individual sterile Petri dishes in duplicate. A 1.0 mL aliquot of a diluted suspension of the test organism (serially diluted to target approximately 100 CFU) was added to each dish. Approximately 15-25 mL of TGEA was added to each Petri dish, swirled to mix and allowed to harden. A volume of 1.0 mL of the diluted test organism suspension was also plated as a numbers control to verify the amount of organism inoculated. This control was performed with multiple replicates representing different dilutions of the test organism. The control result is reported using data from the most appropriate dilution. The acceptance criterion for this study control is growth within  $\pm 1.0 \log_{10}$  of the neutralization confirmation numbers control.

## **STUDY ACCEPTANCE CRITERIA**

### **Test Substance Performance Criteria**

The EPA efficacy performance requirements for label claims state that a sanitizer must show a 99.999% reduction of the test organism within 30 seconds.

### **Control Acceptance Criteria**

The study controls must perform according to the criteria detailed in the study controls description section.

## **PROTOCOL CHANGES**

### **Protocol Amendments:**

No protocol amendments were required for this study.

### **Protocol Deviations:**

No protocol deviations occurred during this study.

## **DATA ANALYSIS**

### **Calculations**

$$\text{CFU/mL} = \frac{(\text{Average number of survivors on duplicate plate counts}) \times (\text{Test dilution})}{(\text{Volume plated})}$$

$$\text{Test dilution} = \frac{10 \text{ (Test)}}{10^6 \text{ (Numbers Control)}}$$

$$\text{Percent Reduction} = 1 - (\text{average of survivors/average numbers control}) \times 100$$

Five digits were used when calculating Percent Reduction values.

### **Statistical Analysis**

None used.

## **STUDY RETENTION**

### **Record Retention**

All of the original raw data developed exclusively for this study shall be archived at ATS Labs, 1285 Corporate Center Drive, Suite 110, Eagan, MN 55121. These original data include, but are not limited to, the following:

1. All handwritten raw data for control and test substances including, but not limited to, notebooks, data forms and calculations.
2. Any protocol amendments/deviation notifications.
3. All measured data used in formulating the final report.
4. Memoranda, specifications, and other study specific correspondence relating to interpretation and evaluation of data, other than those documents contained in the final study report.
5. Original signed protocol.
6. Certified copy of final study report.
7. Study-specific SOP deviations made during the study.

### **Test Substance Retention**

The test substance will be discarded following study completion per Sponsor approved protocol. It is the responsibility of the Sponsor to retain a sample of the test material.

## **REFERENCES**

1. Official Methods of Analysis of the AOAC, Seventeenth Edition, 2000. Chapter 6-Disinfectants, 960.09. Germicidal and Detergent Sanitizing Action of Disinfectants with modifications as described in the experimental design.
2. U.S. Environmental Protection Agency, Registration Division, Office of Pesticide Programs, 1979. Efficacy Data Requirements, Sanitizing rinses (for previously cleaned food-contact surfaces), DIS/TSS-4.
3. U.S. Environmental Protection Agency, Registration Division, Office of Pesticide Programs, 1979. Efficacy Data Requirements, Supplemental Recommendations, DIS/TSS-2.

## **RESULTS**

### **For Control and Neutralization Results, see Tables 1, 2 and 7.**

All data measurements/controls including the culture purity, viability, organic soil sterility, diluent sterility, PBDW sterility, subculture agar sterility, neutralizer sterility, numbers control, and neutralization confirmation controls were within acceptance criteria. Furthermore, antibiotic resistance verification results met established standard acceptance criteria.

### **For Numbers Control and Test Results, see Table 3-6.**



## ANALYSIS

Enagic Super 501 Strong Acidic Water 2.5 pH, Machine 1 (Serial #: 87100333) Lot # 1 and Machine 2 (Serial #: 87100339) Lot # 2 with pre-filter C-1000, demonstrated a >99.999 percent reduction of *Staphylococcus aureus* following a 30 second exposure time at room temperature (20.0°C) in the presence of a 5% fetal bovine serum organic soil load.

Enagic Super 501 Strong Acidic Water 2.5 pH, Machine 1 (Serial #: 87100333) Lot # 1 and Machine 2 (Serial #: 87100339) Lot # 2 with pre-filter C-1000, demonstrated a >99.999 percent reduction of *Escherichia coli*, following a 30 second exposure time at room temperature (20.0°C) in the presence of a 5% fetal bovine serum organic soil load.

Enagic Super 501 Strong Acidic Water 2.5 pH, Machine 1 (Serial #: 87100333) Lot # 1 and Machine 2 (Serial #: 87100339) Lot # 2 with pre-filter C-1000, demonstrated a >99.999 percent reduction of *Salmonella typhi*, following a 30 second exposure time at room temperature (20.0°C) in the presence of a 5% fetal bovine serum organic soil load.

Enagic Super 501 Strong Acidic Water 2.5 pH, Machine 1 (Serial #: 87100333) Lot # 1 and Machine 2 (Serial #: 87100339) Lot # 2 with pre-filter C-1000, demonstrated a >99.999 percent reduction of Methicillin Resistant *Staphylococcus aureus* – MRSA, following a 30 second exposure time at room temperature (20.0°C) in the presence of a 5% fetal bovine serum organic soil load.

## CONCLUSION

Under the conditions of this assay, Enagic Super 501 Strong Acidic Water 2.5 pH, Machine 1 (Serial #: 87100333) Lot # 1 and Machine 2 (Serial #: 87100339) Lot # 2 with pre-filter C-1000, demonstrated efficacy against *Staphylococcus aureus* for precleaned, nonporous food contact surfaces following a 30 second exposure time at room temperature (20.0°C) in the presence of a 5% fetal bovine serum organic soil load as required by the U.S. EPA for sanitizer label claims

Under the conditions of this assay, Enagic Super 501 Strong Acidic Water 2.5 pH, Machine 1 (Serial #: 87100333) Lot # 1 and Machine 2 (Serial #: 87100339) Lot # 2 with pre-filter C-1000, demonstrated efficacy against *Escherichia coli* for precleaned, nonporous food contact surfaces following a 30 second exposure time at room temperature (20.0°C) in the presence of a 5% fetal bovine serum organic soil load as required by the U.S. EPA for sanitizer label claims

Under the conditions of this assay, Enagic Super 501 Strong Acidic Water 2.5 pH, Machine 1 (Serial #: 87100333) Lot # 1 and Machine 2 (Serial #: 87100339) Lot # 2 with pre-filter C-1000, did demonstrated efficacy against *Salmonella typhi* for precleaned, nonporous food contact surfaces following a 30 second exposure time at room temperature (20.0°C) in the presence of a 5% fetal bovine serum organic soil load as required by the U.S. EPA for sanitizer label claims

Under the conditions of this assay, Enagic Super 501 Strong Acidic Water 2.5 pH, Machine 1 (Serial #: 87100333) Lot # 1 and Machine 2 (Serial #: 87100339) Lot # 2 with pre-filter C-1000, demonstrated efficacy against Methicillin Resistant *Staphylococcus aureus* – MRSA for precleaned, nonporous food contact surfaces after a 30 second exposure time at room temperature (20.0°C) in the presence of a 5% fetal bovine serum organic soil load as required by the U.S. EPA for sanitizer label claims

In the opinion of the Study Director, there were no circumstances that may have adversely affected the quality or integrity of the data.

The use of the ATS Labs name, logo or any other representation of ATS Labs without the written approval of ATS Labs is prohibited. In addition, ATS Labs may not be referred to in any form of promotional materials, press releases, advertising or similar materials (whether by print, broadcast, communication or electronic means) without the express written permission of ATS Labs.

**TABLE 1: CONTROL RESULTS**

The following results from controls confirmed study validity:

Type of Control	Results
Neutralizer Sterility Control	No Growth
Purity Control <i>Staphylococcus aureus</i> (ATCC 6538)	Pure
Purity Control <i>Escherichia coli</i> (ATCC 11229)	Pure
Purity Control <i>Salmonella typhi</i> (ATCC 6539)	Pure
Purity Control Methicillin Resistant <i>Staphylococcus aureus</i> – MRSA (ATCC 33592)	Pure
Viability Control <i>Staphylococcus aureus</i> (ATCC 6538)	Growth
Viability Control <i>Escherichia coli</i> (ATCC 11229)	Growth
Viability Control <i>Salmonella typhi</i> (ATCC 6539)	Growth
Viability Control Methicillin Resistant <i>Staphylococcus aureus</i> – MRSA (ATCC 33592)	Growth
Subculture Agar Sterility Control (before testing)	No Growth
Organic Soil Load Sterility	No Growth
PBDW Sterility Control	No Growth

**TABLE 2: NEUTRALIZATION CONFIRMATION CONTROL RESULTS**

Test Substance	Test Organism	Dilution	Numbers Control Inoculum (1.0 mL)	Volume of Neutralized Inoculated Product		Log Difference	Pass/Fail ± 1.0 Log <sub>10</sub>
			CFU	CFU			
				0.1 mL	1.0 mL	1.0 mL Data	
Enagic Super 501 Strong Acidic Water 2.5 pH, Machine 1 (Serial #: 87100333) Lot # 1 with pre-filter C-1000	<i>Staphylococcus aureus</i> (ATCC 6538)	10 <sup>-9</sup>	13, 15	12, 17	11, 9	0.15	Pass
	<i>Escherichia coli</i> (ATCC 11229)		10, 4	6, 16	13, 8	-0.2	Pass
	<i>Salmonella typhi</i> (ATCC 6539)		6, 8	12, 8	9, 13	-0.2	Pass
	Methicillin Resistant <i>Staphylococcus aureus</i> – MRSA (ATCC 33592)		17, 7	15, 6	11, 9	0.08	Pass
Enagic Super 501 Strong Acidic Water 2.5 pH, Machine 2 (Serial #: 87100339) Lot # 2 with pre-filter C-1000	<i>Staphylococcus aureus</i> (ATCC 6538)		13, 15	12, 20	8, 15	0.07	Pass
	<i>Escherichia coli</i> (ATCC 11229)		10, 4	13, 7	5, 13	-0.2	Pass
	<i>Salmonella typhi</i> (ATCC 6539)		6, 8	11, 15	10, 10	-0.2	Pass
	Methicillin Resistant <i>Staphylococcus aureus</i> – MRSA (ATCC 33592)		17, 7	13, 20	14, 13	-0.07	Pass

CFU = Colony forming unit

**TABLE 3: TEST RESULTS – *Staphylococcus aureus* (ATCC 6538)**

**Raw Data for *Staphylococcus aureus* (ATCC 6538)**

Test Substance	Exposure Time	Run #	Duplicate Plate Counts (CFU/plate) (2 sets of 4 plates for each volume)			
			Number Surviving		Microbes Initially Present	
			Test 0.1 mL of 10 <sup>-1</sup> (in neutralizer)	Test 1.0 mL of 10 <sup>-1</sup> (in neutralizer)	Numbers Control 0.1 mL of 10 <sup>-6</sup>	Numbers Control 1.0 mL of 10 <sup>-6</sup>
Enagic Super 501 Strong Acidic Water 2.5 pH, Machine 1 (Serial #: 87100333) Lot # 1 with pre-filter C-1000	30 seconds	Run 1	0, 0, 0, 0	0, 0, 0, 0	10, 6, 9, 14	75, 80, 74, 77
		Run 2	0, 0, 0, 0	0, 0, 0, 0		
Enagic Super 501 Strong Acidic Water 2.5 pH, Machine 2 (Serial #: 87100339) Lot # 2 with pre-filter C-1000		Run 1	0, 0, 0, 0	0, 0, 0, 0		
		Run 2	0, 0, 0, 0	0, 0, 0, 0		

A value of <1 was used in place of zero for calculation purposes only.

**Calculated Results for *Staphylococcus aureus* (ATCC 6538) by Lot, Exposure, and Corresponding % Reduction**

Test Substance	Exposure Time	Average Number Surviving (CFU/mL)	Microbes Initially Present	Percent Reduction
			Numbers Control (CFU/mL)	
Enagic Super 501 Strong Acidic Water 2.5 pH, Machine 1 (Serial #: 87100333) Lot # 1 with pre-filter C-1000	30 seconds	<1 x 10 <sup>1</sup>	7.7 X 10 <sup>7</sup>	>99.999
Enagic Super 501 Strong Acidic Water 2.5 pH, Machine 2 (Serial #: 87100339) Lot # 2 with pre-filter C-1000		<1 x 10 <sup>1</sup>		>99.999

CFU = Colony Forming Unit

**TABLE 4: TEST RESULTS – *Escherichia coli* (ATCC 11229)**

**Raw Data for *Escherichia coli* (ATCC 11229)**

Test Substance	Exposure Time	Run #	Duplicate Plate Counts (CFU/plate) (2 sets of 4 plates for each volume)			
			Number Surviving		Microbes Initially Present	
			Test 0.1 mL of 10 <sup>-1</sup> (in neutralizer)	Test 1.0 mL of 10 <sup>-1</sup> (in neutralizer)	Numbers Control 0.1 mL of 10 <sup>-6</sup>	Numbers Control 1.0 mL of 10 <sup>-6</sup>
Enagic Super 501 Strong Acidic Water 2.5 pH, Machine 1 (Serial #: 87100333) Lot # 1 with pre-filter C-1000	30 seconds	Run 1	0, 0, 0, 0	0, 0, 0, 0	11, 15, 13, 6	92, 95, 93, 88
		Run 2	0, 0, 0, 0	0, 0, 0, 0		
Enagic Super 501 Strong Acidic Water 2.5 pH, Machine 2 (Serial #: 87100339) Lot # 2 with pre-filter C-1000		Run 1	0, 0, 0, 0	0, 0, 0, 0		
		Run 2	0, 0, 0, 0	0, 0, 0, 0		

A value of <1 was used in place of zero for calculation purposes only.

**Calculated Results for *Escherichia coli* (ATCC 11229) by Lot, Exposure, and Corresponding % Reduction**

Test Substance	Exposure Time	Average Number Surviving (CFU/mL)	Microbes Initially Present	Percent Reduction
			Numbers Control (CFU/mL)	
Enagic Super 501 Strong Acidic Water 2.5 pH, Machine 1 (Serial #: 87100333) Lot # 1 with pre-filter C-1000	30 seconds	<1 x 10 <sup>1</sup>	9.2 x 10 <sup>7</sup>	>99.999
Enagic Super 501 Strong Acidic Water 2.5 pH, Machine 2 (Serial #: 87100339) Lot # 2 with pre-filter C-1000		<1 x 10 <sup>1</sup>		>99.999

CFU = Colony Forming Unit

**TABLE 5: TEST RESULTS – *Salmonella typhi* (ATCC 6539)**

**Raw Data for *Salmonella typhi* (ATCC 6539)**

Test Substance	Exposure Time	Run #	Duplicate Plate Counts (CFU/plate) (2 sets of 4 plates for each volume)			
			Number Surviving		Microbes Initially Present	
			Test 0.1 mL of 10 <sup>-1</sup> (in neutralizer)	Test 1.0 mL of 10 <sup>-1</sup> (in neutralizer)	Numbers Control 0.1 mL of 10 <sup>-6</sup>	Numbers Control 1.0 mL of 10 <sup>-6</sup>
Enagic Super 501 Strong Acidic Water 2.5 pH, Machine 1 (Serial #: 87100333) Lot # 1 with pre-filter C-1000	30 seconds	Run 1	0, 0, 0, 0	0, 0, 0, 0	8, 15, 10, 17	111, 109, 91, 113
		Run 2	0, 0, 0, 0	0, 0, 0, 0		
Enagic Super 501 Strong Acidic Water 2.5 pH, Machine 2 (Serial #: 87100339) Lot # 2 with pre-filter C-1000		Run 1	0, 0, 0, 0	0, 0, 0, 0		
		Run 2	0, 0, 0, 0	0, 0, 0, 0		

A value of <1 was used in place of zero for calculation purposes only.

**Calculated Results for *Salmonella typhi* (ATCC 6539) by Lot, Exposure, and Corresponding % Reduction**

Test Substance	Exposure Time	Average Number Surviving (CFU/mL)	Microbes Initially Present	Percent Reduction
			Numbers Control (CFU/mL)	
Enagic Super 501 Strong Acidic Water 2.5 pH, Machine 1 (Serial #: 87100333) Lot # 1 with pre-filter C-1000	30 seconds	<1 x 10 <sup>1</sup>	1.06 x 10 <sup>8</sup>	>99.999
Enagic Super 501 Strong Acidic Water 2.5 pH, Machine 2 (Serial #: 87100339) Lot # 2 with pre-filter C-1000		<1 x 10 <sup>1</sup>		>99.999

CFU = Colony Forming Unit

**TABLE 6: TEST RESULTS**  
**Methicillin Resistant *Staphylococcus aureus* – MRSA (ATCC 33592)**

**Raw Data for Methicillin Resistant *Staphylococcus aureus* – MRSA (ATCC 33592)**

Test Substance	Exposure Time	Run #	Duplicate Plate Counts (CFU/plate) (2 sets of 4 plates for each volume)			
			Number Surviving		Microbes Initially Present	
			Test 0.1 mL of 10 <sup>-1</sup> (in neutralizer)	Test 1.0 mL of 10 <sup>-1</sup> (in neutralizer)	Numbers Control 0.1 mL of 10 <sup>-6</sup>	Numbers Control 1.0 mL of 10 <sup>-6</sup>
Enagic Super 501 Strong Acidic Water 2.5 pH, Machine 1 (Serial #: 87100333) Lot # 1 with pre-filter C-1000	30 seconds	Run 1	0, 0, 0, 0	0, 0, 0, 0	5, 14, 4, 7	90, 103, 90, 84
		Run 2	0, 0, 0, 0	0, 0, 0, 0		
Enagic Super 501 Strong Acidic Water 2.5 pH, Machine 2 (Serial #: 87100339) Lot # 2 with pre-filter C-1000		Run 1	0, 0, 0, 0	0, 0, 0, 0		
		Run 2	0, 0, 0, 0	0, 0, 0, 0		

A value of <1 was used in place of zero for calculation purposes only.

**Calculated Results for Methicillin Resistant *Staphylococcus aureus* – MRSA (ATCC 33592) by Lot, Exposure, and Corresponding % Reduction**

Test Substance	Exposure Time	Average Number Surviving (CFU/mL)	Microbes Initially Present	Percent Reduction
			Numbers Control (CFU/mL)	
Enagic Super 501 Strong Acidic Water 2.5 pH, Machine 1 (Serial #: 87100333) Lot # 1 with pre-filter C-1000	30 seconds	<1 x 10 <sup>1</sup>	9.2 x 10 <sup>7</sup>	>99.999
Enagic Super 501 Strong Acidic Water 2.5 pH, Machine 2 (Serial #: 87100339) Lot # 2 with pre-filter C-1000		<1 x 10 <sup>1</sup>		>99.999

CFU = Colony Forming Unit



**TABLE 7: VERIFICATION OF ANTIBIOTIC RESISTANCE**

<b>Test Organism (ATCC)</b>	<b>Zone of Inhibition (mm)</b>	<b>CLSI* Resistant Range (mm)</b>
Methicillin Resistant <i>Staphylococcus aureus</i> (ATCC 33592)	6	≤ 10
<b>Quality Control Organism (ATCC)</b>	<b>Zone of Inhibition (mm)</b>	<b>CLSI* Acceptable Range (mm)</b>
<i>Staphylococcus aureus</i> (ATCC 25923)	18	18 - 24

\*CLSI = Clinical and Laboratory Standards Institute

(For Laboratory Use Only)  
ATS Labs Project # **A 09385**

LC 4/21/10

**ATS LABS**

**PROTOCOL**

**Germicidal and Detergent  
Sanitizing Action of Disinfectants**

**Test Organisms:**

*Escherichia coli* (ATCC 11229)  
*Staphylococcus aureus* (ATCC 6538)  
*Salmonella typhi* (ATCC 6539)  
Methicillin Resistant *Staphylococcus aureus* – MRSA (ATCC 33592)

EXACT COPY  
INITIALS MA DATE 6-22-10

**PROTOCOL NUMBER**

YNR01040110.GDST

**PREPARED FOR**

YNR Marketing  
Box 7735  
Laguna Nigel, CA 92607

**PERFORMING LABORATORY**

ATS Labs  
1285 Corporate Center Drive, Suite 110  
Eagan, MN 55121

**PREPARED BY**

Anne Stemper, B.S.  
Research Scientist I

**DATE**

April 1, 2010

**PROPRIETARY INFORMATION**

THIS DOCUMENT IS THE PROPERTY OF AND CONTAINS PROPRIETARY INFORMATION OF ATS LABS. NEITHER THIS DOCUMENT, NOR INFORMATION CONTAINED HEREIN IS TO BE REPRODUCED OR DISCLOSED TO OTHERS, IN WHOLE OR IN PART, NOR USED FOR ANY PURPOSE OTHER THAN THE PERFORMANCE OF THIS WORK ON BEHALF OF THE SPONSOR, WITHOUT PRIOR WRITTEN PERMISSION OF ATS LABS.

## **Germicidal and Detergent Sanitizing Action of Disinfectants**

**SPONSOR:** YNR Marketing  
Box 7735  
Laguna Nigel, CA 92607

**TEST FACILITY:** ATS Labs  
1285 Corporate Center Drive, Suite 110  
Eagan, MN 55121

### **PURPOSE**

The purpose of this assay is to determine the minimum concentration of chemical that can be used in sanitizing pre-cleaned, nonporous food contact surfaces using the AOAC Germicidal and Detergent Sanitizing Action of Disinfectants method.

### **TEST SUBSTANCE CHARACTERIZATION**

Test substance characterization as to content, stability, etc., (40 CFR, Part 160, Subpart F [160.105]) is the responsibility of the Sponsor. The test substance shall be characterized by the Sponsor prior to the experimental start date of this study. Pertinent information, which may affect the outcome of this study, shall be communicated in writing to the Study Director upon sample submission to ATS Labs.

### **SCHEDULING AND DISCLAIMER OF WARRANTY**

Experimental start dates are generally scheduled on a first-come/first-serve basis once ATS Labs receives the Sponsor approved/completed protocol, signed fee schedule and corresponding test substance(s). Based on all required materials being received at this time, the proposed experimental start date is April 20, 2010. Verbal results may be given upon completion of the study with a written report to follow on the proposed completion date of May 10, 2010. To expedite scheduling, please be sure all required paperwork and test substance documentation is complete/accurate upon arrival at ATS Labs.

If a test must be repeated, or a portion of it, due to failure by ATS Labs to adhere to specified procedures, it will be repeated free of charge. If a test must be repeated, or a portion of it, due to failure of internal controls, it will be repeated free of charge. "Methods Development" fees shall be assessed, however, if the test substance and/or test system require modifications due to complexity and difficulty of testing. If testing is to be performed at other than the typical test temperature ( $25 \pm 1^\circ\text{C}$ ) the Sponsor will be responsible for repeat testing due to a numbers control failure.

If the Sponsor requests a repeat test, they will be charged for an additional test.

Neither the name of ATS Labs or any of its employees are to be used in advertising or other promotion without written consent from ATS Labs.

The Sponsor is responsible for any rejection of the final report by the regulating agency concerning report format, pagination, etc. To prevent rejection, Sponsor should carefully review the ATS Labs final report and notify ATS Labs of any perceived deficiencies in these areas before submission of the report to the regulatory agency. ATS Labs will make reasonable changes deemed necessary by the Sponsor, without altering the technical data.

### **JUSTIFICATION FOR SELECTION OF THE TEST SYSTEM**

The U.S. Environmental Protection Agency requires that a specific bacterial claim for a sanitizer intended for use on food contact surfaces be supported by appropriate scientific data demonstrating the efficacy of the sanitizer against the claimed bacteria. This is accomplished by treating the target bacteria with the sanitizer (test substance) under conditions which simulate as closely as possible, in the laboratory, the actual conditions under which the sanitizer is designed to be used. For sanitizer products intended for use on food contact surfaces, a suspension method is used in the generation of the supporting data. The experimental design in this protocol meets these requirements. The test system to be used in this study will follow the AOAC approved method for the determination of the Germicidal and Detergent Sanitizing Activity of Disinfectants.

- Proprietary Information -

1285 Corporate Center Drive, Suite 110 • Eagan, MN 55121 • 877.287.8378 • 651.379.5510 • Fax: 651.379.5549

**TEST PRINCIPLE**

A suspension of bacterial cells is exposed to the sanitizer for a specified exposure time. After exposure, an aliquot of the exposed suspension is transferred to vessels containing neutralizing subculture media and assayed for survivors. Appropriate numbers control, purity, sterility, viability, and neutralization controls are performed. The current version of Standard Operating Procedure CGT-4100 reflects the methods which shall be used in this study.

**TEST METHOD**

Test Organisms	ATCC #	Growth Medium	Incubation Parameters
<i>Escherichia coli</i>	11229	Nutrient Agar A & B	35-37°C, aerobic
<i>Staphylococcus aureus</i>	6538	Nutrient Agar A & B	35-37°C, aerobic
<i>Salmonella typhi</i>	6539	Nutrient Agar A & B	35-37°C, aerobic
Methicillin Resistant <i>Staphylococcus aureus</i> - MRSA	33592	Nutrient Agar A & B	35-37°C, aerobic

Each test organism used in this study was obtained from the American Type Culture Collection (ATCC), Manassas, VA.

Subculture Medium: Tryptone Glucose Extract Agar (TGEA)

Neutralizer: Suitable for the test substance

**Preparation of Test Organism**

For *Staphylococcus aureus*, the test organism will be transferred daily on Nutrient agar A slants. Three to thirty consecutive daily transfers will be performed prior to the inoculation of agar bottles. The bacterial growth will be washed from a 24 ± 2 hour Nutrient Agar A slant of the test organism using 5.0 mL phosphate buffer dilution water (PBDW). This growth suspension will be aspirated and added to 99 mL PBDW. A 2 mL aliquot of this suspension will be inoculated onto sufficient French square bottles containing Nutrient agar B. The bottles will be tilted back and forth to distribute the inoculum. The excess inoculum will be aspirated off. The bottles will be incubated for 18-24 hours at 35-37°C (agar side down). After incubation, the culture will be harvested from the bottles using PBDW and sterile glass beads to target 1 x 10<sup>10</sup> CFU / mL. Typically 1.5 mL of PBDW, per bottle, is used to harvest the test organism. The suspension will be removed from the bottles, filtered through sterile Whatman No. 2 paper or sterile gauze pre-wetted with approximately 1.0 mL sterile of PBDW, and collected into a sterile vessel. A spectrophotometric reading of approximately 2.4 at 620 nm will be targeted. The culture may be further adjusted, if necessary, to target approximately 1 x 10<sup>10</sup> CFU / mL.

For *Escherichia coli*, the test organism will be transferred daily on Nutrient agar A slants. Three to thirty consecutive daily transfers will be performed prior to the inoculation of agar bottles. The bacterial growth will be washed from a 24 ± 2 hour Nutrient Agar A slant of the test organism using 5.0 mL phosphate buffer dilution water (PBDW). This growth suspension will be aspirated and added to 99 mL PBDW. A 2 mL aliquot of this suspension will be inoculated onto sufficient French square bottles containing Nutrient agar B. The bottles will be tilted back and forth to distribute the inoculum. The excess inoculum will be aspirated off. The bottles will be incubated for 18-24 hours at 35-37°C (agar side down). After incubation, the culture will be harvested from the bottles using PBDW and sterile glass beads to target 1 x 10<sup>10</sup> CFU / mL. Typically 3 mL of PBDW, per bottle, is used to harvest the test organism. The suspension will be removed from the bottles, filtered through sterile Whatman No. 2 paper or sterile gauze pre-wetted with approximately 1.0 mL sterile of PBDW, and collected into a sterile vessel. A spectrophotometric reading of approximately 1.8 at 620 nm will be targeted. The culture may be further adjusted, if necessary, to target approximately 1 x 10<sup>10</sup> CFU / mL.

- Proprietary Information -

1285 Corporate Center Drive, Suite 110 • Eagan, MN 55121 • 877.287.8378 • 651.379.5510 • Fax: 651.379.5549

*Salmonella typhi* will be transferred daily on Nutrient agar A agar slants. Three to thirty consecutive daily transfers will be performed prior to the inoculation of agar bottles. The bacterial growth will be washed from a  $24 \pm 2$  hour slant of the test organism using 5.0 mL phosphate buffer dilution water (PBDW). This growth suspension will be aspirated and added to 99 mL PBDW. A 2 mL aliquot of this suspension will be inoculated onto sufficient French square bottles containing Nutrient agar B. The bottles will be tilted back and forth to distribute the inoculum. The excess inoculum will be aspirated off. The bottles will be incubated for 18-24 hours at 35-37°C (agar side down). After incubation, each suspension will be harvested from the bottles using PBDW and sterile glass beads to target  $1 \times 10^{10}$  CFU / mL. Typically, 1 mL of PBDW is used, per bottle, to harvest this organism. A spec value of approximately 1.9 at 620nm should be targeted. (Alternate volumes of PBDW or culture adjustments may be used/where appropriate). The suspension will be removed from the bottles, filtered through sterile Whatman No. 2 paper or sterile gauze pre-wetted with approximately 1.0 mL sterile of PBDW, and collected into a sterile vessel.

Methicillin Resistant *Staphylococcus aureus* will be transferred daily on Nutrient agar A agar slants. Three to thirty consecutive daily transfers will be performed prior to the inoculation of agar bottles. The bacterial growth will be washed from a  $24 \pm 2$  hour slant of the test organism using 5.0 mL phosphate buffer dilution water (PBDW). This growth suspension will be aspirated and added to 99 mL PBDW. A 2 mL aliquot of this suspension will be inoculated onto sufficient French square bottles containing Nutrient agar B. The bottles will be tilted back and forth to distribute the inoculum. The excess inoculum will be aspirated off. The bottles will be incubated for 18-24 hours at 35-37°C (agar side down). After incubation, each suspension will be harvested from the bottles using PBDW and sterile glass beads to target  $1 \times 10^{10}$  CFU / mL. Typically, 3 mL of PBDW is used, per bottle, to harvest this organism. A spec value of approximately 2.0 at 620nm should be targeted. The culture may be further diluted as necessary. (Alternate volumes of PBDW or culture adjustments may be used/where appropriate). The suspension will be removed from the bottles, filtered through sterile Whatman No. 2 paper or sterile gauze pre-wetted with approximately 1.0 mL sterile of PBDW, and collected into a sterile vessel.

An organic soil load may be added to the test culture or test substance per Sponsor's request.

Antimicrobial susceptibility testing will be performed utilizing a representative culture from the day of testing to verify the antimicrobial resistance pattern stated.

#### Preparation of Test Substance

The test substance(s) to be assayed will be used as directed by the Sponsor. If a dilution of the test substance is requested by the Sponsor, the diluted test substance(s) shall be used within three hours of preparation.

#### Inoculation of Flasks

Duplicate 250 – 300 mL Erlenmeyer flasks containing 99 mL of the test substance at the concentration to be tested will be prepared and placed into a waterbath at the Sponsor specified exposure temperature (typically  $25 \pm 1^\circ\text{C}$ ). The test substance will be allowed to equilibrate for  $\geq 20$  minutes.

The flask containing the test substance will be whirled in a circular motion stopping just before the suspension is added, creating enough residual motion of liquid to prevent pooling of the suspension at the point of contact with test substance. One (1.0) mL of culture will be added midway between the center and edge of the surface with the tip of the pipette slightly immersed in the test solution. Touching the neck or side of the flasks will be avoided.

#### Neutralization/Subculture

At each specified exposure time point, one (1.0) mL of the inoculated test substance will be transferred to 9 mL of neutralizer. The neutralizer will be vortex mixed. Four 1.0 mL and 0.1 mL aliquots will be transferred to individual sterile Petri dishes. A sufficient volume (approximately 15-25 mL) of tryptone glucose extract agar will be transferred to each Petri dish and each dish will be allowed to solidify.

- Proprietary Information -

1285 Corporate Center Drive, Suite 110 • Eagan, MN 55121 • 877.287.8378 • 651.379.5510 • Fax: 651.379.5549

### **Incubation and Observation**

All subculture plates will be incubated for 48±4 hours at 35-37°C. Subculture plates may be stored at 2-8°C for up to 3 days prior to reading.

Following incubation (or incubation and storage), the subculture plates will be visually examined for growth.

Representative subculture plates showing growth will be stained and/or biochemically assayed to confirm or rule out the presence of the test organism. Additional subcultures may be performed, if necessary.

### **STUDY CONTROLS**

#### **Numbers Control**

Prior to the addition of the organism, vessels containing 99 mL of PBDW will be placed into a waterbath at the Sponsor specified exposure temperature (typically 25±1°C) and equilibrated for ≥20 minutes. For each organism, one (1.0) mL of the prepared culture suspension will be added to 99 mL of PBDW representing the "Test Substance". One (1.0) mL of this suspension will be added to 99 mL PBDW (Dilution 1, representing the 10<sup>-2</sup> dilution). After mixing thoroughly, 1.0 mL of Dilution 1 will be transferred to 99 mL PBDW (Dilution 2, representing the 10<sup>-4</sup> dilution). A third dilution will be made using 1.0 mL Dilution 2 into 99 mL PBDW (Dilution 3, representing the 10<sup>-6</sup> dilution). Four 1.0 mL and 0.1 mL aliquots from Dilution 3 will be transferred to individual Petri dishes. A sufficient volume (approximately 15-25 mL) of tryptone glucose extract agar will be transferred to each plate and the plates will be allowed to solidify. The plates will be incubated and enumerated. The acceptance criterion for this study control is a calculated result between 75 and 125 x 10<sup>6</sup> CFU/mL of "test substance".

#### **Purity Control**

A "streak plate for isolation" will be performed on the organism culture and following incubation examined in order to confirm the presence of a pure culture. The acceptance criterion for this study control is a pure culture demonstrating colony morphology typical of the test organism.

#### **Organic Soil Sterility Control**

If applicable, 1.0 mL of soil used in testing will be added to a tube of Fluid Thioglycollate medium (FTM). The FTM tube(s) will be incubated, and visually examined for lack of growth. The acceptance criterion for this study control is no growth.

#### **Neutralizer Sterility Control**

A representative sample of neutralizer (1.0 mL), per lot of neutralizer used in testing, will be transferred to a sterile Petri dish and pour plated as in the test. The plate will be incubated and visually examined. The acceptance criterion for this study control is no growth.

#### **Diluent Sterility Control**

If applicable, a representative sample of test substance diluent (1.0 mL), per lot used in testing, will be transferred to a sterile Petri dish and pour plated as in the test. The plate will be incubated and visually examined. The acceptance criterion is no growth.

#### **PBDW Sterility Control**

A representative sample of PBDW (1.0 mL), per lot used on the day of test, will be transferred to a sterile Petri dish and pour plated as in the test. The plate will be incubated and visually examined. The acceptance criterion is no growth.

#### **Subculture Agar Sterility Control**

An aliquot of the subculture agar, per lot used in testing, will be poured into a sterile Petri dish at the end of testing. The plate will be incubated and visually examined. The acceptance criterion is no growth.

– Proprietary Information –

1285 Corporate Center Drive, Suite 110 • Eagan, MN 55121 • 877.287.8378 • 651.379.5510 • Fax: 651.379.5549

**Viability Control**

An aliquot of each test organism (0.1 mL) will be transferred to a sterile Petri dish and pour plated as in the test. The plate(s) will be incubated and visually examined. The acceptance criterion for this study control is growth.

**Neutralization Confirmation Control**

A neutralization control sample will be prepared by adding 1.0 mL of test substance to 9 mL of neutralizer. (Note: If multiple concentrations are prepared in testing, only the most concentrated sample needs to be evaluated.) The neutralization control sample(s) will be vortex mixed. Duplicate 1.0 mL and 0.1 mL aliquots of the neutralization control sample will be added to sterile Petri dishes. One (1.0) mL of test organism suspension (serially diluted to target approximately 100 CFU) will be added to each dish. (Multiple dilutions of test organism may be utilized.) An identical aliquot of test organism will be placed into sterile Petri dishes, in duplicate, as a numbers control. A sufficient volume (approximately 15-25 mL) of tryptone glucose extract agar will be transferred to each Petri dish and each dish will be allowed to solidify. The plates will be incubated and enumerated.

The control result will be reported using data from the most appropriate organism dilution. The acceptance criterion for this study control is growth within 1.0 log<sub>10</sub> of the neutralization confirmation numbers control.

**PROCEDURE FOR IDENTIFICATION OF THE TEST SYSTEM**

ATS Labs maintains Standard Operating Procedures (SOPs) relative to efficacy testing studies. Efficacy testing is performed in strict adherence to these SOPs which have been constructed to cover all aspects of the work including, but not limited to, receipt, log-in, and tracking of biological reagents including bacterial strains for purposes of identification, receipt and use of chemical reagents. These procedures are designed to document each step of efficacy testing studies. Appropriate references to medium batch number, etc. are documented in the raw data collected during the course of each study.

Additionally, each efficacy test is assigned a unique Project Number when the protocol for the study is initiated by the Study Director. This number is used for identification of the test subculture tubes, etc. during the course of the test. Test subculture tubes are also labeled with reference to the test organism, experimental start date, and test product. Microscopic and macroscopic evaluations of positive subcultures are performed in order to confirm the identity of the test organism. These measures are designed to document the identity of the test system.

**METHOD FOR CONTROL OF BIAS: NA**

**STUDY ACCEPTANCE CRITERIA**

**Test Substance Performance Criteria**

The EPA efficacy performance requirements for label claims state that a sanitizer must show a minimum of 99.999% reduction of the test organism as compared to the numbers control within 30 seconds.

**Control Acceptance Criteria**

The study controls must perform according to the criteria detailed in the study controls description section. If any of the control acceptance criteria are not met, the test may be repeated under the current protocol.

**REPORT**

The report will include, but not limited to, identification of the sample and date received, initiation and completion dates, identification of the bacterial strains used, description of media and reagents, description of the methods employed, tabulated results and conclusion as it relates to the purpose of the test, and all other items required by 40 CFR Part 160.185.

- Proprietary Information -

1285 Corporate Center Drive, Suite 110 • Eagan, MN 55121 • 877.287.8378 • 651.379.5510 • Fax: 651.379.5549

**PROTOCOL CHANGES**

If it becomes necessary to make changes in the approved protocol, the revision and reasons for changes will be documented, reported to the Sponsor and will become a part of the permanent file for that study. Similarly, the Sponsor will be notified as soon as possible whenever an event occurs that may have an effect on the validity of the study.

Standard operating procedures used in this study will be the correct effective revision at the time of the work. Any minor changes to SOPs (for this study) or methods used will be documented in the raw data and approved by the Study Director.

**PRODUCT DISPOSITION**

*It is the responsibility of the Sponsor to retain a sample of the test material. All unused test material will be discarded following study completion unless otherwise indicated by Sponsor.*

**RECORD RETENTION**

**Study Specific Documents**

All of the original raw data developed exclusively for this study shall be archived at ATS Labs. These original data include, but are not limited to, the following:

1. All handwritten raw data for control and test substances including, but not limited to, notebooks data, forms and calculations.
2. Any protocol amendments/deviation notifications.
3. All measured data used in formulating the final report.
4. Memoranda, specifications, and other study specific correspondence relating to interpretation, and evaluation of data, other than those documents contained in the final study report.
5. Original signed protocol.
6. Certified copy of final study report.
7. Study-specific SOP deviations made during the study.

**Facility Specific Documents**

The following records shall also be archived at ATS Labs. These documents include, but are not limited to, the following:

1. SOPs which pertain to the study conducted.
2. Non study-specific SOP deviations made during the course of this study which may affect the results obtained during this study.
3. Methods which were used or referenced in the study conducted.
4. QA reports for each QA inspection with comments.
5. Facility Records: Temperature Logs (ambient, incubator, etc.), Instrument Logs, Calibration and Maintenance Records).
6. Current curriculum vitae, training records, and job descriptions for all personnel involved in the study.

- Proprietary Information -

1285 Corporate Center Drive, Suite 110 • Eagan, MN 55121 • 877.287.8378 • 651.379.5510 • Fax: 651.379.5549



**REFERENCES**

1. Official Methods of Analysis of the AOAC, Seventeenth Edition, 2000. Chapter 6-Disinfectants, 960.09. Germicidal and Detergent Sanitizing Action of Disinfectants with modifications as described in the experimental design.
2. U.S. Environmental Protection Agency, Registration Division, Office of Pesticide Programs, 1979. Efficacy Data Requirements, Sanitizing rinses (for previously cleaned food-contact surfaces), DIS/TSS-4.
3. U.S. Environmental Protection Agency, Registration Division, Office of Pesticide Programs, 1979. Efficacy Data Requirements, Supplemental Recommendations, DIS/TSS-2.

**DATA ANALYSIS**

**Calculations**

$$\text{CFU/mL} = \frac{\text{(average number of survivors on duplicate plate counts)} \times \text{(test dilution)}}{\text{(volume plated)}}$$

$$\text{Test dilution} = \frac{10 \text{ (Test)}}{10^6 \text{ (Numbers Control)}}$$

$$\text{Percent Reduction} = 1 - (\text{average of survivors/average numbers control}) \times 100$$

Five digits will be used when calculating Percent Reduction values.

**Statistical Analysis:** None used

- Proprietary Information -

1285 Corporate Center Drive, Suite 110 • Eagan, MN 55121 • 877.287.8378 • 651.379.5510 • Fax: 651.379.5549

APR 01 10 02:05p YNR MARKETING

9492189683

p.9

Protocol Number: YNR01040110.GDST

YNR Marketing  
Page 9 of 10

ATS LABS

STUDY INFORMATION

(All sections must be completed prior to submitting protocol)

\* Sponsor (Date/Initial): 4/1/10  
Enagic Super 501 Strong Acidic Water 2.5 pH Machine 1 (serial #: 87100233) Lot #1 and Machine 2 (serial #: 87100239) Lot #2 with pre-filter C-1000  
Test Substance (Name & Batch Numbers, including 260 day old batch - exactly as it should appear on final report):  
2.5 pH STRONG ACIDIC WATER DISPOSED FROM SPS01 WITH PRE-FILTER C-1000  
Expiration Date NA Specify ≥60 day old batch: NA

Product Description:

- Quaternary ammonia
- Peroxide
- Peracetic acid
- Sodium hypochlorite
- Iodophor
- Other Strong Acidic Water

Test Substance Active Concentration (upon submission to ATS Labs): approximately 2.5 pH

Neutralization/Subculture Broth:

- 
- ATS Labs' Discretion. By checking, the Sponsor authorizes ATS Labs, at their discretion, to perform neutralization confirmation assays at the Sponsor's expense prior to testing to determine the most appropriate neutralizer. (See Fee Schedule).

Storage Conditions:

- Room Temperature
- 2-8°C
- Other: \_\_\_\_\_

\* all entries made per Sponsor clarification M 4-13-10

Hazards:

- None known: Use Standard Precautions
- Material Safety Data Sheet, Attached for each product
- As Follows: \_\_\_\_\_

Product Preparation

- No dilution required, Use as received (RTU)
- \*Dilution(s) to be tested: \_\_\_\_\_ defined as \_\_\_\_\_ + \_\_\_\_\_ (example: 1 oz/gallon) (amount of test substance) (amount of diluent)
- Deionized Water (Filter or Autoclave Sterilized)
- Tap Water (Filter or Autoclave Sterilized) point of use tap water
- AOAC Synthetic Hard Water: \_\_\_\_\_ PPM
- Other \_\_\_\_\_

\*Note: An equivalent dilution may be made unless otherwise requested by the Sponsor.

Test Organism(s):

- Staphylococcus aureus (ATCC 6538)
- Escherichia coli (ATCC 11229)
- Salmonella typhi (ATCC 6539)
- Methicillin Resistant Staphylococcus aureus (ATCC 33592)

Exposure Time: 30 Seconds

Exposure Temperature\*:  25 ± 1°C  
 Other: room temperature

\* If testing is to be performed at other than the typical test temperature (25 ± 1°C) the Sponsor will be responsible for repeat testing due to a numbers control failure.

Organic Soil Load:

- Minimum 5% Organic Soil Load (Fetal Bovine Serum in Test Substance)
- Minimum 5% Organic Soil Load (Fetal Bovine Serum in Organism Suspension)
- No Organic Soil Load Required

- Proprietary information -

Apr 01 10:02:05p YNR MARKETING 9492189683 p.10

Protocol Number: YNR01040110.GDST

YNR Marketing  
Page 10 of 10

ATS LABS

**TEST SUBSTANCE SHIPMENT STATUS**

- Has been used in one or more previous studies at ATS Labs .
- Has been shipped to ATS Labs (but has not been used in a previous study).  
Date shipped to ATS Labs: \_\_\_\_\_ Sent via overnight delivery?  Yes  No
- Will be shipped to ATS Labs.  
Date of expected receipt at ATS Labs: \_\_\_\_\_
- Sender (if other than Sponsor): \_\_\_\_\_

**COMPLIANCE**

Study to be performed under EPA Good Laboratory Practice regulations (40 CFR Part 160) and in accordance to standard operating procedures.

- Yes
- No (Non-GLP Study)

**PROTOCOL MODIFICATIONS**

- Approved without modification
- Approved with modification - Supplemental Information Form Attached -  Yes  No

*Box checked per Sponsor clarification as 4-13-10*

**APPROVAL SIGNATURES**

**SPONSOR:**

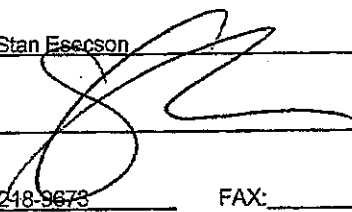
NAME: Stan Esecson TITLE: VP  
SIGNATURE:  DATE: 4/1/10  
PHONE: 949-248-9873 FAX: \_\_\_\_\_ EMAIL: stan@ynrmarketing.com

For confidentiality purposes, study information will be released only to the sponsor/representative signing the protocol (above) unless other individuals are specifically authorized in writing to receive study information.

Other individuals authorized to receive information regarding this study:  See Attached

**ATS Labs:**

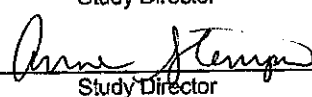
NAME: Anne Stempur  
Study Director  
SIGNATURE:  DATE: 4-19-10  
Study Director

- Proprietary Information -

1285 Corporate Center Drive, Suite 110 • Eagan, MN 55121 • 877.287.8378 • 651.379.5510 • Fax: 651.379.5549

Attachment to YNR01040110.GDST

Page 1 of 12

M 4-13-10

EXACT COPY  
INITIALS/DATE 6-22-10

**Procedure Notes for the Operation of Enagic Super 501 (production of strong acidic water 2.5 pH)**

*A total of two machines will be used to generate the water necessary for testing. The machines are designated as Machine 1 (serial # 87100333 and Machine 2 (serial # 87100339). Machine 1 will generate lot 1 of strong acidic water (test substance) and Machine 2 will generate lot 2 of strong acidic water (test substance). These machines will be used in combination with the pre-filter C-1000 supplied by the Sponsor.*

**Precautions:**

1. For the storage of strong acidic water, use containers made of glass, plastic, ceramic or other non-corrosive material. Avoid the use of metal containers.
2. Do not place anything on the water processor body.
3. Do not close the discharge hose opening and keep the secondary hose level lower than the level of the water processor body
4. The water discharge hoses and the flexible pipes should be extended over the sink.
5. Take care with the plug and the power cord. Keep water away from the power plug and do not use the machine if the power cord appears damaged.

**Accessories and Name of Parts:**

Refer to pages 7 -10 from the Sponsor provided operations manual for the individual machine parts and location of machine functions.

**Installation of the Machine:**

1. Install the corporation cock in an appropriate manner compatible with the tap water faucet. Refer to page 12 of the Sponsor provided operations manual (1-2: Installing the Corporation Cock) for complete instructions.
2. For installation of the main machine unit, refer to page 13 of the Sponsor provided operations manual (1-3: Installing the Main Unit).
3. In addition to installing the machine, the Sponsor has also supplied a filter unit. Connect the filter unit to the faucet and the machine using the appropriate connection tubes supplied by the Sponsor.

**Priming of the Machine:**

*This is an "out of the box" set up step and will only be required once for each machine unit.*

After the machine has been connected, press the "Kangen Water" (pH approximately 9.5) button located on the top operation panel. Turn on the tap water faucet and allow the water to run for 5 minutes or until the water is running completely clear. This signals that the filter is clean and the machine is ready for use.

**Production of Strong Acidic Water (pH 2.5)**

**Important Notes:**

1. *When producing Strong Acidic Water, check that the built-in tank is filled with the ionizing accelerator (sodium chloride). Verify that the "Low Saltwater Level" lamp does not illuminate or is not blinking before producing Strong Acidic Water.*
2. *For the ionizing accelerator, be sure to use salt containing 99% or more sodium chloride, as other agents will damage the unit.*

Attachment to YNR 01040110, GDST  
page 2 of 12

M 4-13-10

EXACT COPY  
INITIALS *AD* DATE 6-22-10

3. The flow rate for the tap water faucet used for the machine should be approximately 0.4 gallons/minute. The machine will display a warning signal if the flow rate is too slow. Minimize the flow rate of the water until the Increase Water Flow message appears on the machine display. Increase the water flow just enough to exceed the threshold. This action will ensure the flow rate is sufficient to be operating the machine within the operational guidelines.

**Procedure Notes for the Operation of Enagic Super 501 (production of strong acidic water 2.5 pH)**  
(continued)

**Refer to pages 18-20 of the Sponsor provided operations manual (2-3: Producing Strong Acidic Water for illustrations and comprehensive instructions.**

*This section includes instructions for preparing the ionizing accelerator (sodium chloride), filling the built-in tank with the ionizing accelerator, the production of strong acidic water and the pH of the final strong acidic water product.*

The tap water temperature should target room temperature. Per Sponsor request, record the temperature of the tap water running through the machine before generating any strong acidic water. There is no acceptance criteria for this parameter.

The machine will always be turned on first, the water supply will be turned on next, and then the "Strong Acid" button located on the operation panel will be pressed. Press the "Stop" button located on the operation panel when the generation of strong acidic water is no longer required.

ATS Labs will take one pH reading for each lot of strong acidic water generated and record the pH value. Perform the pH determination at room temperature. Record the temperature of the strong acidic water in addition to recording the pH. The pH of the sample should not be higher than 2.8. If it is higher than 2.8, remake the strong acidic water sample by performing all applicable previously described instructions.

Each lot of strong acidic water generated maybe stored for up to 24 hours at room temperature in a sterile container protected from the light prior to use in testing.

**Cleaning/Maintenance**

When finished using the machine, detach the built-in sodium chloride tank and rinse it well with tap water. While the unit is stopped, using the Sponsor provided wash bottle, feed approximately 20-50 cc of tap water through the air discharge pipe located at the upper part of the unit to clean the crystallized sodium chloride in the hose.

Refer to page 22 of the Sponsor provided operations manual (Cleaning inside the sodium chloride tank and air discharge pipe) for complete instructions and illustration.

Attachment to YNR 01040110.GDST

page 3 of 12  
As 4-13-10

EXACT COPY  
INITIALS / DATE 6-22-10

### Accessories

■ Check that the following accessories are included in the package.

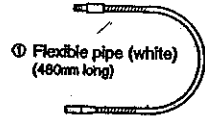

① Flexible pipe (white)  
(480mm long)

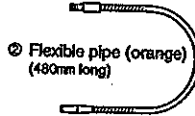

② Flexible pipe (orange)  
(480mm long)

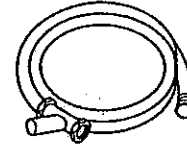

③ Water supply hose with strainer



④ Diverter with nut

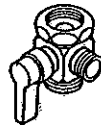

⑤ Corporation cock

⑥ pH test kit TYS-020E

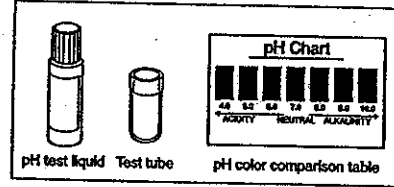

pH test liquid Test tube  
pH color comparison table

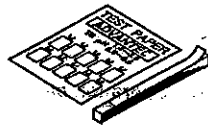

⑦ Book pH test paper

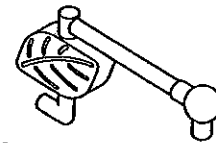
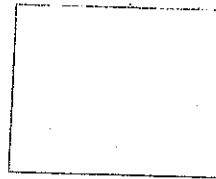

⑧ Secondary acidic water stand  
(with suction pad)

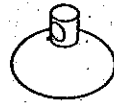

⑨ #12 Suction pad (1 pc.)



⑩ Measuring cup

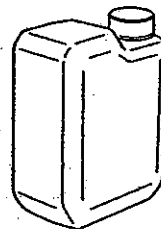

⑪ 2-liter polyethylene tank



⑫ Funnel



⑬ Operation manual

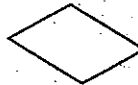

⑭ Warranty card



⑮ Water filter change label

Attachment to YNR 01040110, G-DSU

Page 4 of 12  
M 4-13-10



Name of each parts

EXACT COPY  
INITIALS *M* DATE 6-22-10

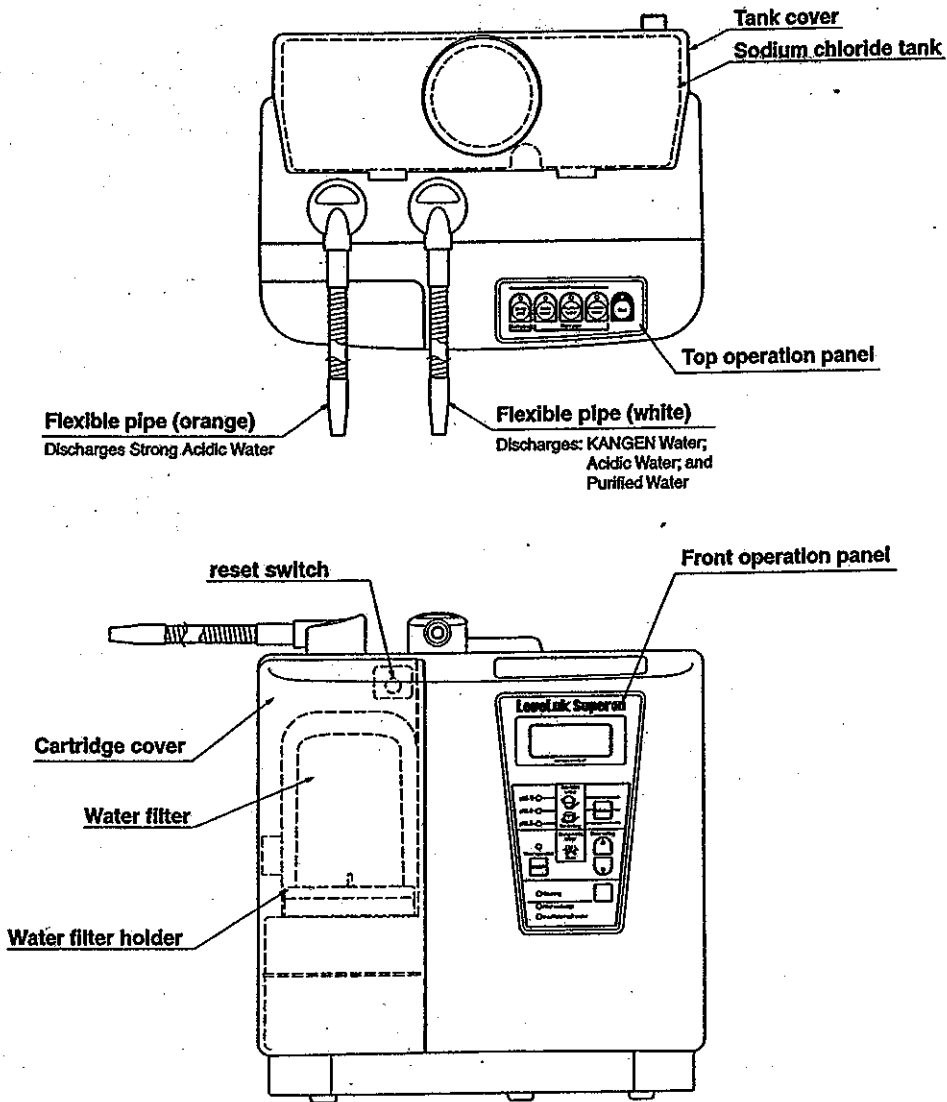

Attachment to YNR 01040110.GDST  
Page 5 of 12  
MS 4-13-10

EXACT COPY  
INITIALS *M* DATE 6-22-10

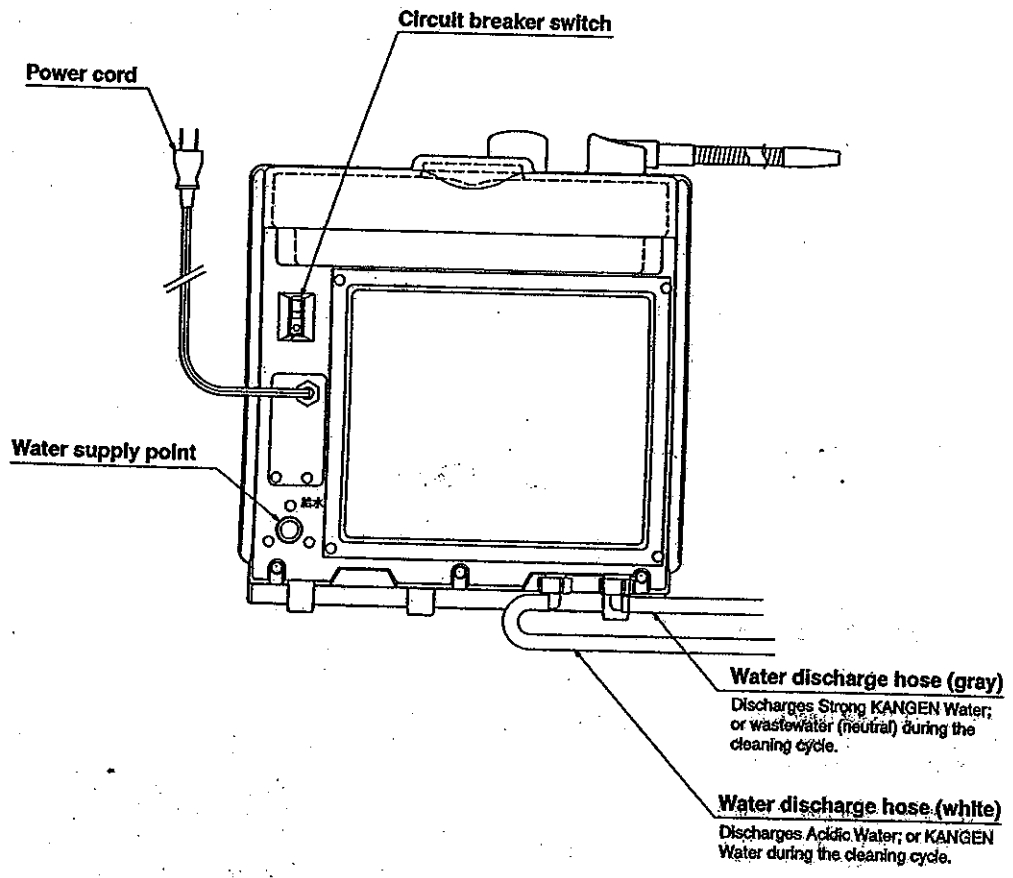



Attachment to YNR01040110.GDST

page 6 of 12  
 M 4-13-10

EXACT COPY  
 INITIALS [Signature] DATE 6-22-10

## Displays and Description on Operation Panel

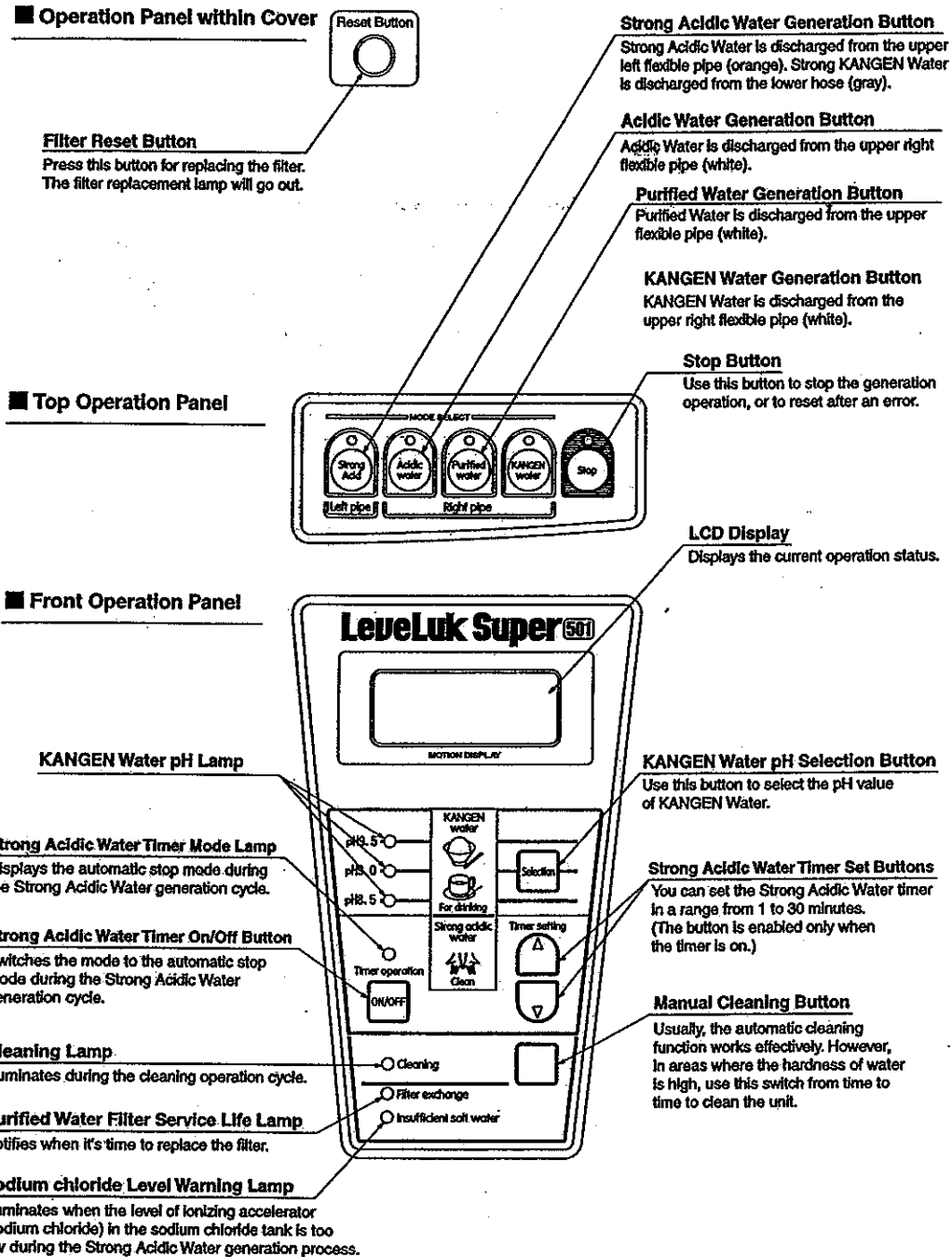

Attachment to YNR01040110.GDST

page 7 of 12 to 4-13-16

EXACT COPY  
INITIALS / DATE 6-22-16

# 1-2 Installing the Corporation Cock

● In case of a general type of faucet and the mixing faucet (installation is feasible by using the standard accessory.)

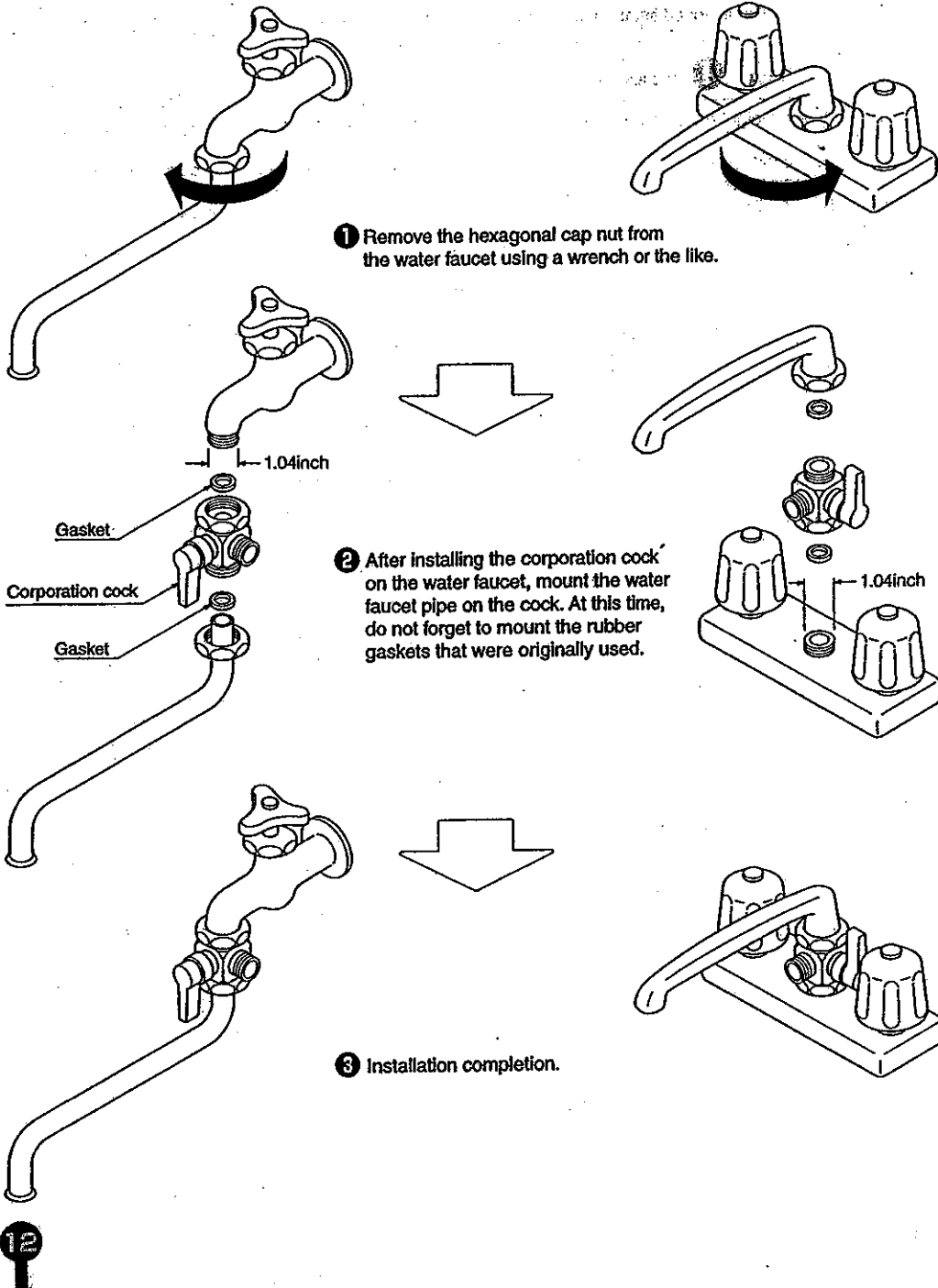

Le

Attachment to YNR01040110.GDST

# 1-3 Installing the Main Unit

page 8 of 12 M 4-13-10

EXACT COPY  
INITIALS *MS* DATE 6-22-10

1 Preparations

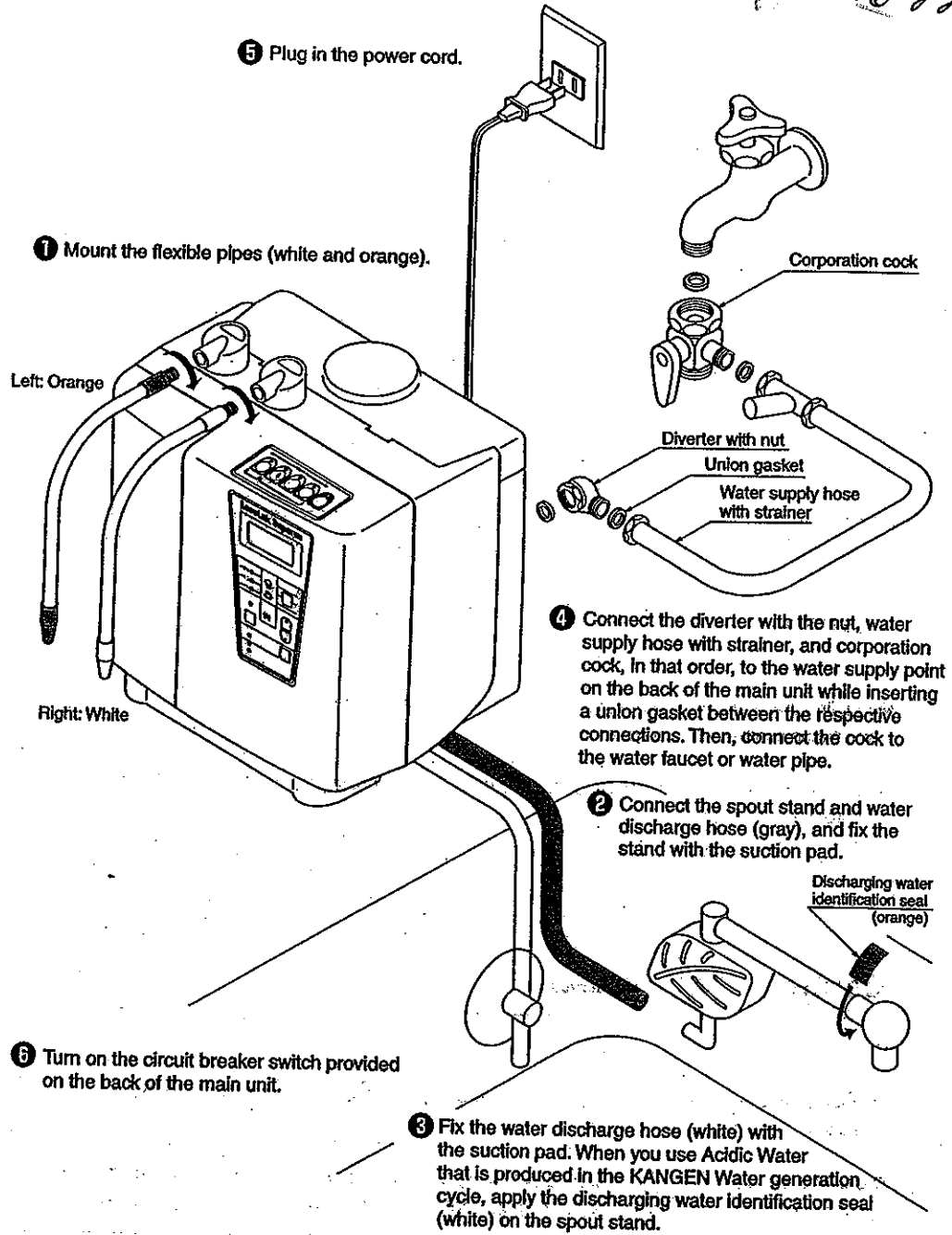

Attachment to YNR01040110.GDST

2-3

page 9 of 12 M 4-13-10

EXACT COPY  
INITIALS *MS* DATE 6-22-10

2.1

### Producing Strong Acidic Water/Strong KANGEN Water

#### ⚠ Caution

- When producing Strong Acidic Water or Strong KANGEN Water, check that the built-in tank is filled with the ionizing accelerator (sodium chloride). (Check that the [Low Saltwater Level lamp] does not illuminate or is not blinking before producing Strong Acidic Water or Strong KANGEN Water.)
- The unit will stop operation approximately 1 minute and 30 seconds after the [Low Saltwater Level] lamp starts blinking.

#### ⚠ Caution

[Precautions on the ionizing accelerator (salt)]

- For the ionizing accelerator, be sure to use salt (table salt commercially available, etc.) (containing 99% or more sodium chloride). Use of agents other than salt may cause deteriorated unit performance or damage the unit.



#### ⚠ Caution

When producing Strong Acidic Water or Strong KANGEN Water, be sure to put the ionizing accelerator (sodium chloride) in the built-in tank.

### 1. Preparing the ionizing accelerator (sodium chloride)

- 1 Prepare 225cc of salt (approx.300g) by measuring it with the measuring cup that comes with the unit.



- 2 Put the measured salt from step 1 in the tank (2 liters) that comes with the unit, and fill the tank with tap water up to the level marked on the tank. Cap the tank, and stir the solution until the salt is completely dissolved.

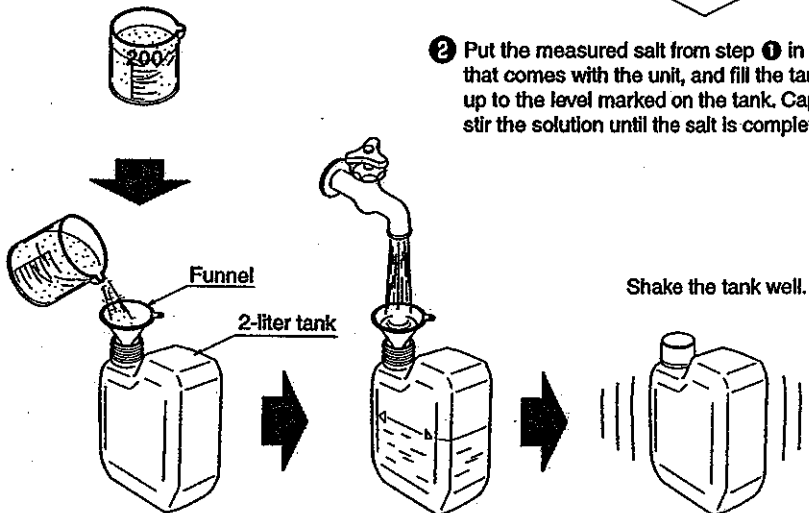

Attachment to YNR01040110. G-DST

Page 10 of 12 MS 4-13-10

2. Put the ionizing accelerator (sodium chloride) in the built-in tank.

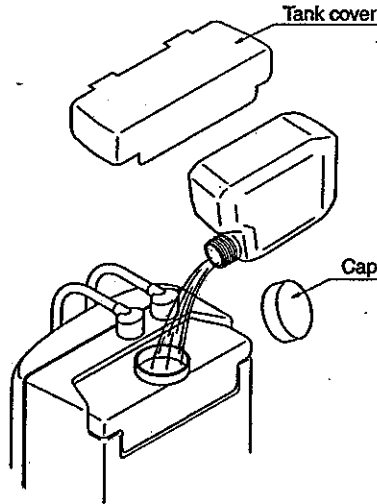

1 Detach the tank cover located at the upper part of the back of the main unit.



2 Unscrew the cap to the tank, and put the sodium chloride prepared in the earlier step.

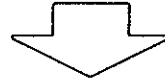

3 Cap the tank.



4 Mount the tank cover.

EXACT COPY  
INITIALS JP DATE 6-22-10

**⚠ Caution**

- Be sure to completely dissolve the agent in water.
- Be sure to observe the specified salt concentration (approx. 25%).
- Do not spill the solution in the unit, since leakage of the ionizing accelerator may cause unit failures. If the solution is spilled, immediately wipe it off.
- If the tank is not supposed to be used for a long period of time, clean the inside of the tank with water.

Attachment to YNR 01040110.GDST  
 Page 11 of 12  
 11-4-13-10

■ Producing Strong Acidic Water

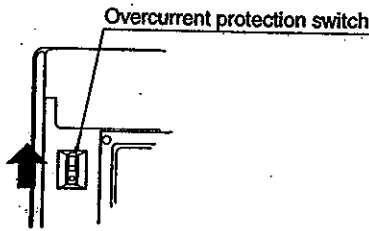

1 Set the overcurrent protection switch on the back of the main unit to the [ON] position.

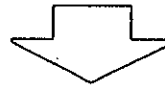

2 Press the [Strong Acidic Water] button located on the top operation panel. Strong Acidic Water will be discharged from the left flexible pipe (orange). [Strong KANGEN Water will be discharged from the water discharge hose (gray).]

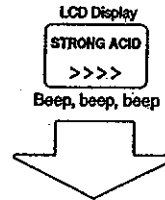

3 Press the [Stop] button on the top operation panel. Discharging of Strong Acidic Water from the left flexible pipe (orange) and Strong KANGEN Water from the water discharge hose (gray) will stop, and the LCD display goes off.



How to measure pH in Strong Acidic Water.

• Book pH test paper (attached) will be used.

■ Use pH test paper (included).

1 Carefully dip the pH test paper in the water sample (less than half a second). Then take out immediately.



2 Shake the pH test paper gently to remove excess water.



3 Check the color of the wet portion of the paper against standard color chart.



※ Color comparison and determination must be done in a brightly lit place.

⚠ Caution You are requested to observe

- The pH test liquid (red) can not measure the pH value down to 4.0. For measuring the pH value of Strong Acidic Water, use the pH test paper, which can measure pH value lower than 3.
- The pH test paper can only be used to check pH value of Strong Acidic Water.
- Do not lick pH paper. If you do, wash out your mouth and gargle immediately.
- Dipping the test paper too long (longer than 0.5 sec) causes the pigment to be dissolved into the sample water, resulting in inaccurate test results.
- Leaving the pH test paper too long once it is removed from the sample water allows water... and may result in inaccurate results.
- The sample water must be kept at room temperature to prevent pigment from diffusing too rapidly, as it would at high temperatures.
- The pH test paper may look different depending on storage conditions. This will not affect any of its properties or abilities.
- The pH test paper must be kept cool and dry in a dark place.

Attachment to YNR 01040110. GDST

Page 12 of 12

11-4-13-10

EXACT COPY  
INITIALS / DATE 6-22-20

## Cleaning inside the sodium chloride tank and air discharge pipe

- When you do not produce Strong Acidic Water with the LevelLuk Super 501 for a long period of time (one week or longer), we recommend that you detach the sodium chloride tank and clean it with water.
- Since the unit uses high concentrations of sodium chloride water, the quantity of sodium chloride in the tank may not be correctly measured due to the collection of crystallized sodium chloride in the tank.

### ● For the best condition:

Execute the following once every several months

- Detach the sodium chloride tank. Alternatively, operate the unit under the Strong Acidic Water Mode until the sodium chloride water in the tank is used up and the unit automatically stops operation.
- While the unit is stopped, feed 20 to 50 cc of tap water from the accompanying wash bottle through the air discharge pipe located at the upper part of the unit to clean the crystallized sodium chloride in the hose.

